

**GENERAL NOTES**

- For additional notes and legends see Standard Drawing E 801-TCLG-01 or E 801-TC DV-02.
- A Type C warning light will be required on tapers where there is a reduction in the number of lanes and a flashing arrow sign is used..

W = White Reflective Sheeting  
O = Orange Reflective Sheeting

<b>INDIANA DEPARTMENT OF TRANSPORTATION</b>	
<b>CHANNELIZING DEVICES</b>	
<b>SEPTEMBER 2007</b>	
<b>STANDARD DRAWING NO. E 801-TC DV-01</b>	
	<p><i>/s/ Richard L. VanCleave</i> 09/04/07 DESIGN STANDARDS ENGINEER DATE</p> <p><i>/s/ Mark A. Miller</i> 09/04/07 CHIEF HIGHWAY ENGINEER DATE</p>
<b>DESIGN STANDARDS ENGINEER</b>	

GENERAL NOTES

1. Unless otherwise specified, channelizing devices shall be spaced as shown on Standard Drawing E 801-TCLG-01.
- ② Reflectorized bands may be omitted from cones for lane closures during daylight hours.
- ③ For vertical panels greater than 3 ft in height, the width of the stripes shall be 6 in.
- ④ Vertical panels used on an expressway or a freeway shall have a minimum reflective panel area of 270 in<sup>2</sup>. Other roadways with a posted speed limit of 50 mph or greater shall also have a minimum reflective panel area of 270 in<sup>2</sup>.
- ⑤ Cones shall have a minimum height of 2'-4" when used at night.
- ⑥ The maximum distance between the edges of adjacent reflective sheeting strips shall be 2 in.
7. Panel and direction indicator barricades and supports shall meet NCHRP 350 crash evaluation criteria.
- ⑧ Minimum flexible tubular marker base area shall be 0.3 ft.<sup>2</sup>
- ⑨ It is not necessary to delineate a drop-off of 3 in. or less adjacent to active travel lanes. Where channellizing devices are used to delineate drop-offs of 3 in. or less adjacent to active travel lanes, at least 33 in. of the device shall be above the adjoining pavement surface. Where channelizing devices are used to delineate a drop-off greater than 3 in. adjacent to active travel lanes, at least 27 in. of the device shall be above the adjoining pavement surface. In no case shall more than 9 in. of the device be below the adjoining pavement surface.
10. The proper orientation in respect to approaching vehicular traffic shall be maintained on vertical panels. Drums are the preferred channelizing device in a tight radius curve.

LEGEND

- O - Device may be used in tangent set-ups.
- X - Device may be used in taper or transition set-ups.
- ⊗ - Devices may be used in two-way traffic set-ups to divide opposing lanes of traffic.
- ⦿ - Device may be used to divide two or more lanes of traffic in the same direction.
- ⊖ - Device may be used to replace barricades and drums where space is limited.
- ◻ - Device may be used to delineate edge of pavement drop-off where space is limited.

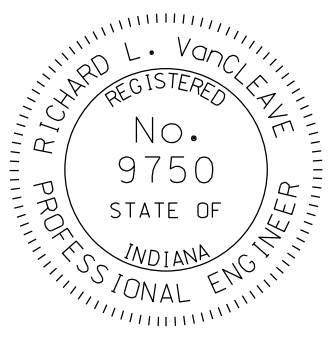
INDIANA DEPARTMENT OF TRANSPORTATION									
CHANNELIZING DEVICES									
SEPTEMBER 2009									
STANDARD DRAWING NO. E 801-TCDV-02									
	<table style="width: 100%; border: none;"> <tr> <td style="border: none;">/s/ <i>Richard L. VanCleave</i></td> <td style="border: none; text-align: right;">09/01/09</td> </tr> <tr> <td style="border: none; font-size: small;">DESIGN STANDARDS ENGINEER</td> <td style="border: none; text-align: right; font-size: small;">DATE</td> </tr> <tr> <td style="border: none;">/s/ <i>Mark A. Miller</i></td> <td style="border: none; text-align: right;">09/01/09</td> </tr> <tr> <td style="border: none; font-size: small;">CHIEF HIGHWAY ENGINEER</td> <td style="border: none; text-align: right; font-size: small;">DATE</td> </tr> </table>	/s/ <i>Richard L. VanCleave</i>	09/01/09	DESIGN STANDARDS ENGINEER	DATE	/s/ <i>Mark A. Miller</i>	09/01/09	CHIEF HIGHWAY ENGINEER	DATE
/s/ <i>Richard L. VanCleave</i>	09/01/09								
DESIGN STANDARDS ENGINEER	DATE								
/s/ <i>Mark A. Miller</i>	09/01/09								
CHIEF HIGHWAY ENGINEER	DATE								
DESIGN STANDARDS ENGINEER									

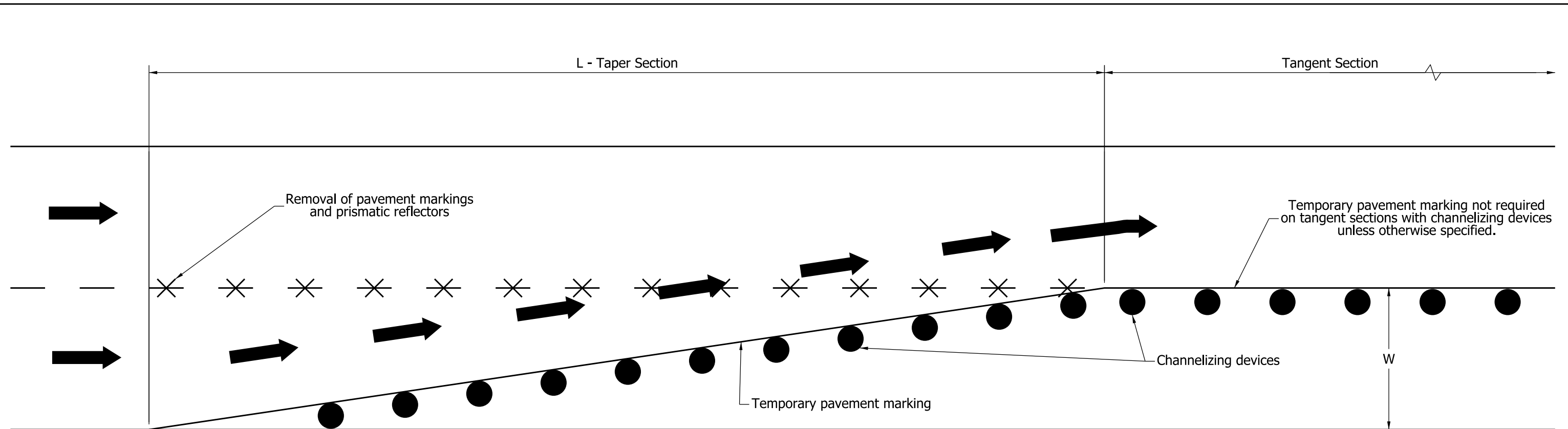

**LEGEND**

- L - Minimum length of taper in feet.
- S - Posted speed limit prior to the construction zone in mph.
- W - Width of offset in feet.

S	L			
	W = 9	W = 10	W = 11	W = 12
MPH				
20	60	70	70	80
25	90	100	120	130
30	140	150	170	180
35 & 40	180 & 240	200 & 270	220 & 300	250 & 320
45	400	450	500	540
50	450	500	550	600
55	500	550	610	660
65	590	650	720	780

The values of L for speeds of 45 mph or greater are based on the equation  $L = W \times S$ . The values for speeds of less than 40 mph or lower are based on the equation  $L = W \times S^2/60$ . For both equations, L and W are in feet and S is mph. These equations are taken from the MUTCD. The taper lengths used in the field, may be either the values provided in the table or calculated values from the equations. For offset widths other than those used in the table, the taper lengths shall be calculated based on the equations.

INDIANA DEPARTMENT OF TRANSPORTATION

MERGING OR SHIFTING TAPER

SEPTEMBER 2009

STANDARD DRAWING NO. E 801-TCDV-03

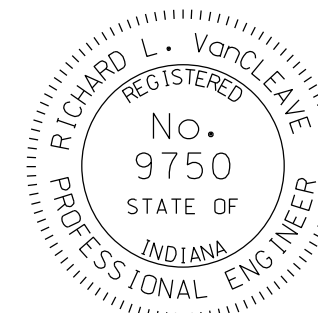

DESIGN STANDARDS ENGINEER

*/s/ Richard L. VanCleave* 09/01/09  
DESIGN STANDARDS ENGINEER DATE

*/s/ Mark A. Miller* 09/01/09  
CHIEF HIGHWAY ENGINEER DATE

General Notes

1. Barricades lights, signs, and supports shall meet NCHRP 350 crash evaluation criteria.
- ② The Detour Arrow sign shall be used only when a detour route has been signed.

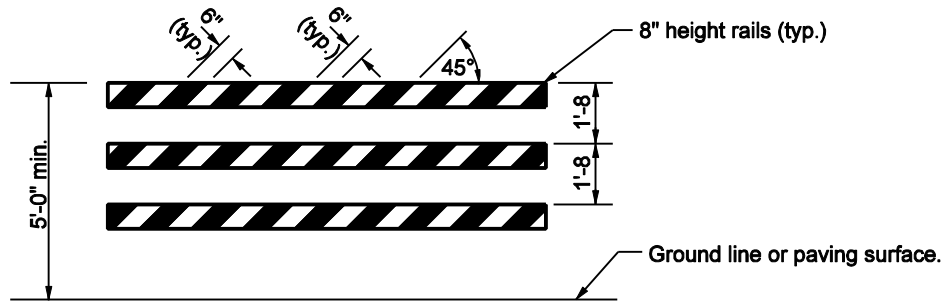

TYPE III BARRICADE

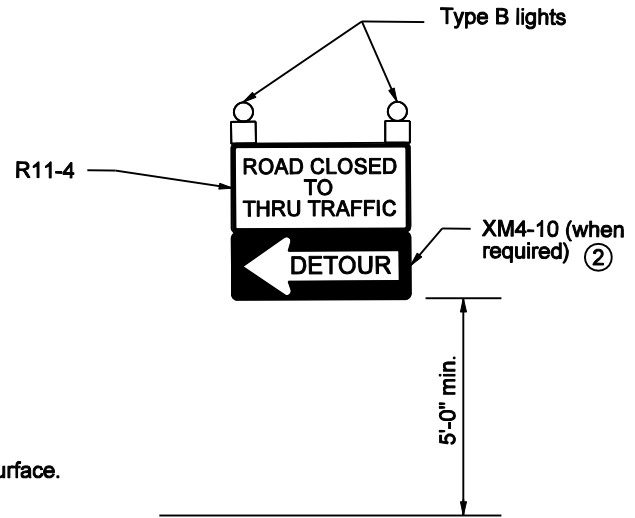

INDIANA DEPARTMENT OF TRANSPORTATION	
TYPE III BARRICADE	
SEPTEMBER 2002	
STANDARD DRAWING NO. E 801-TCDV-04	
	/s/ Richard L. VanCleave 9-03-02 DESIGN STANDARDS ENGINEER DATE
DESIGN STANDARDS ENGINEER	/s/ Richard K. Smutzer 9-03-02 CHIEF HIGHWAY ENGINEER DATE

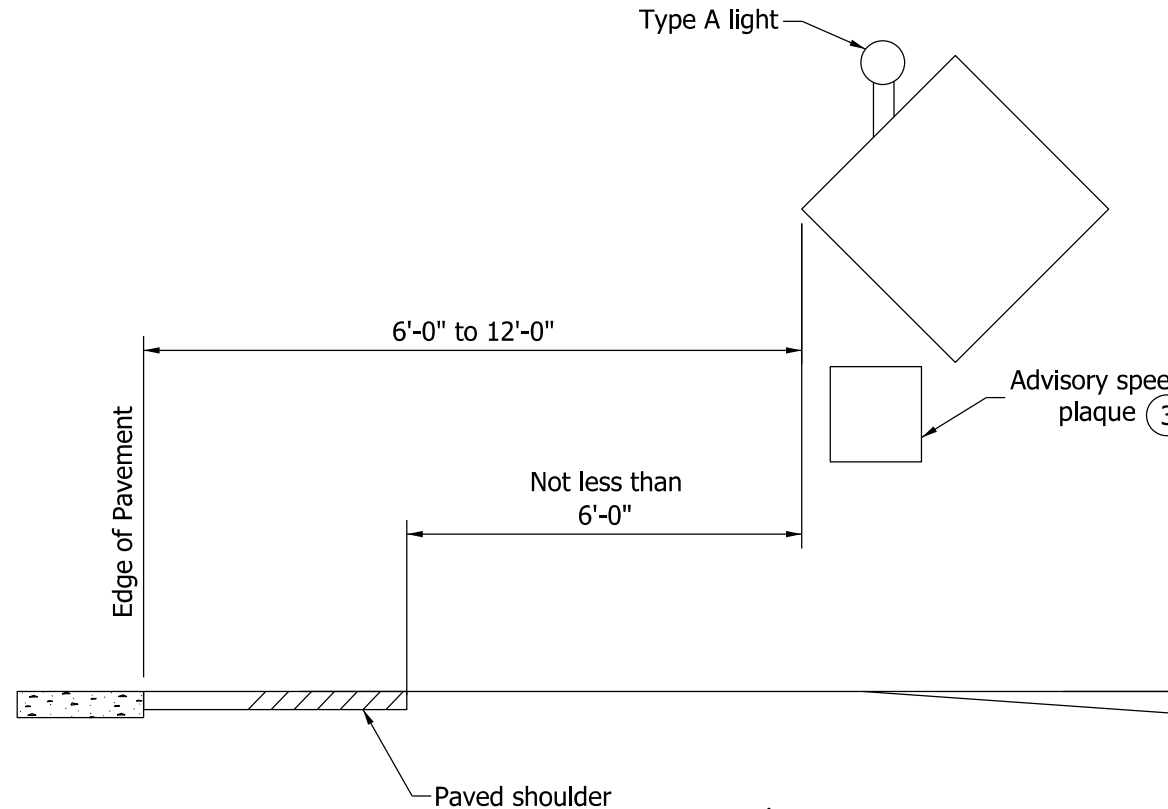
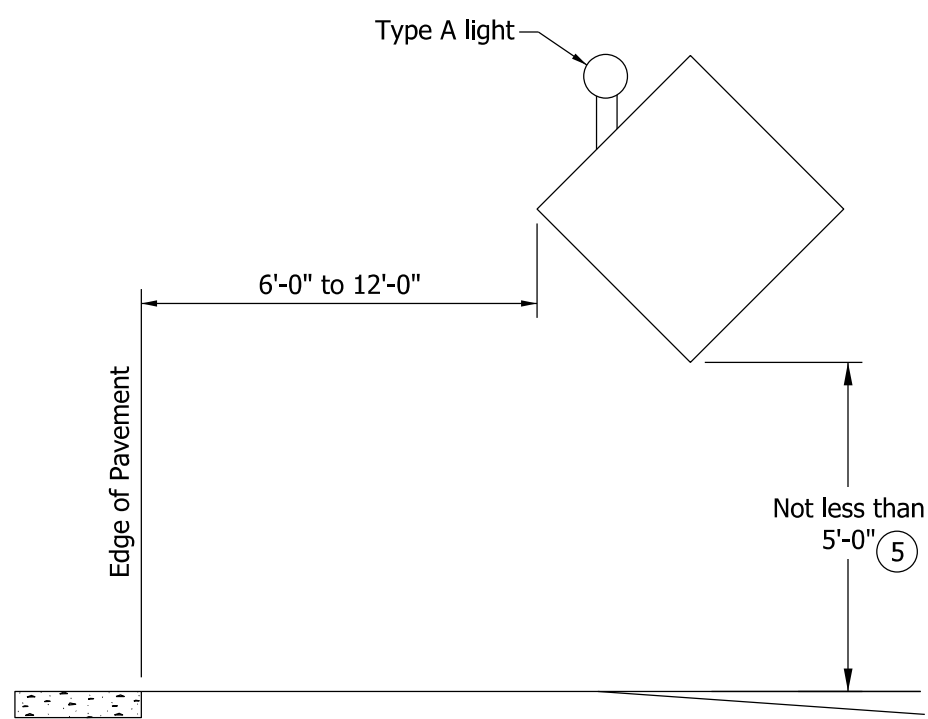

**UN-CURBED ROADWAY**

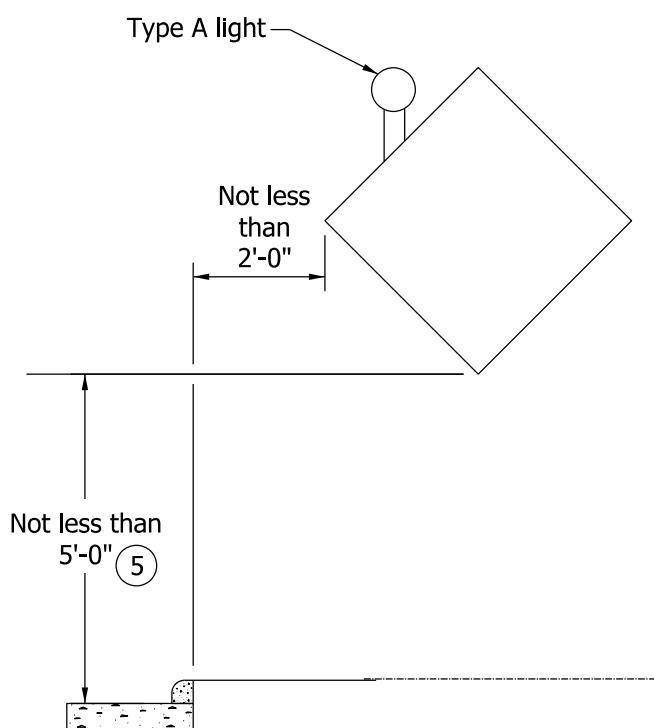
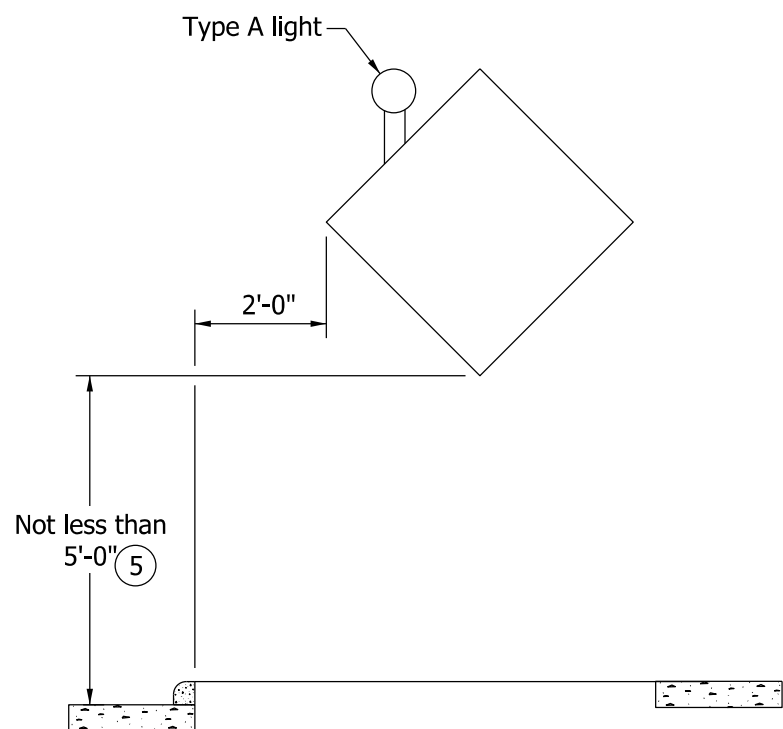

**CURBED ROADWAY**

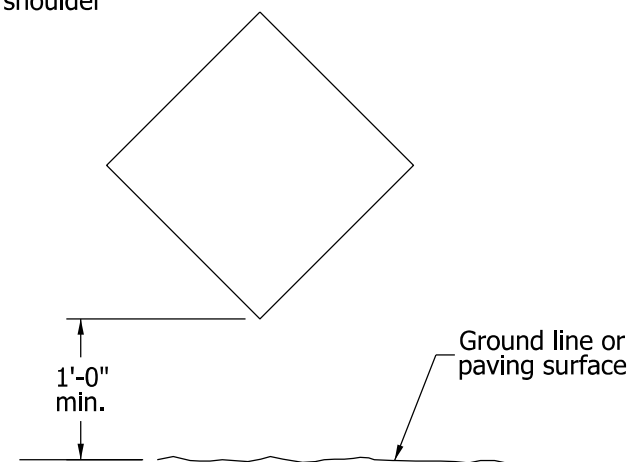

**TEMPORARY MOUNTED CONSTRUCTION SIGN**

**NOTES:**

1. See Standard Drawing E 801-TCSN-11 for additional notes.
- ② Signs, lights, and supports shall satisfy NCHRP 350 crash evaluation criteria.
- ③ An advisory speed plaque, required to be placed with another construction sign, may be mounted on the post closest to the roadway at a height not less than 4 ft above the edge of pavement adjacent to the sign. The bottom of the construction warning sign shall not be lower than the top of the advisory speed plaque.
4. Type A warning light required on all construction signs.
- ⑤ In urban area or on Interstate route, mounting height shall not be less than 7 ft.

INDIANA DEPARTMENT OF TRANSPORTATION

TYPICAL CONSTRUCTION SIGNS MOUNTING

SEPTEMBER 2002

STANDARD DRAWING NO. E 801-TCDV-05

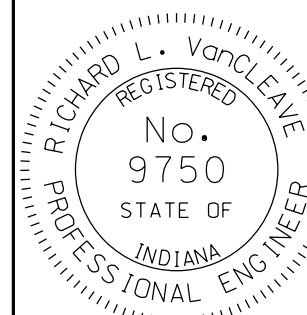

DETAILS PLACED IN THIS FORMAT 09/04/12

/s/ Richard L. VanCleave 09/04/12

SUPERVISOR, ROADWAY STANDARDS DATE

/s/ Mark A. Miller 09/04/12

CHIEF ENGINEER DATE

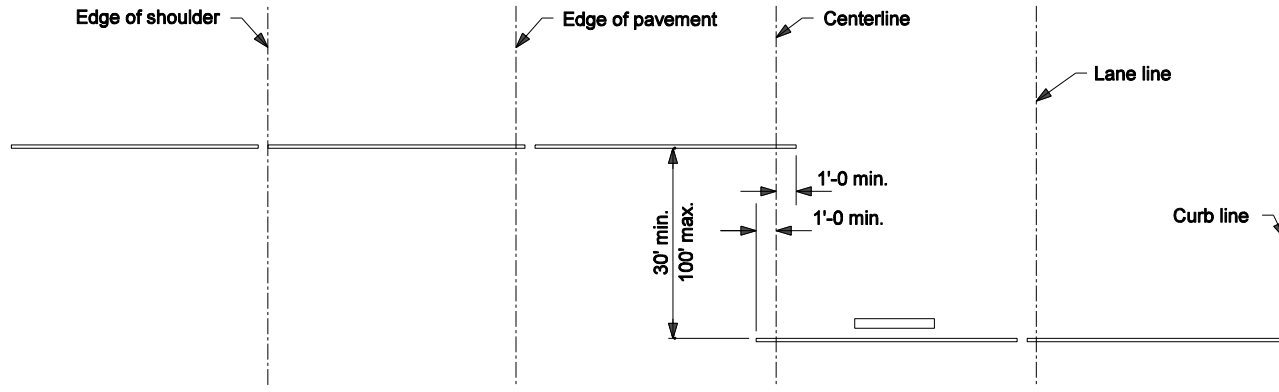

(HALF PLAN WITH SHOULDER SECTION)

PLAN VIEW

(HALF PLAN WITH CURB SECTION)

- GENERAL NOTES**
1. The Detour Arrow sign shall be used only when a detour route has been signed.
  2. Barricades shall be supported on driven posts in areas outside of the pavement or sidewalk, where side slopes are 3 to 1 or flatter.
  3. See standard drawing E 801-TCDV-04 for sign use and mounting information.
  4. Barricades and supports shall meet NCHRP 350 crash evaluation criteria.
  5. See Note 4 on Standard Drawing E 801-TCSN-11 for post depth.

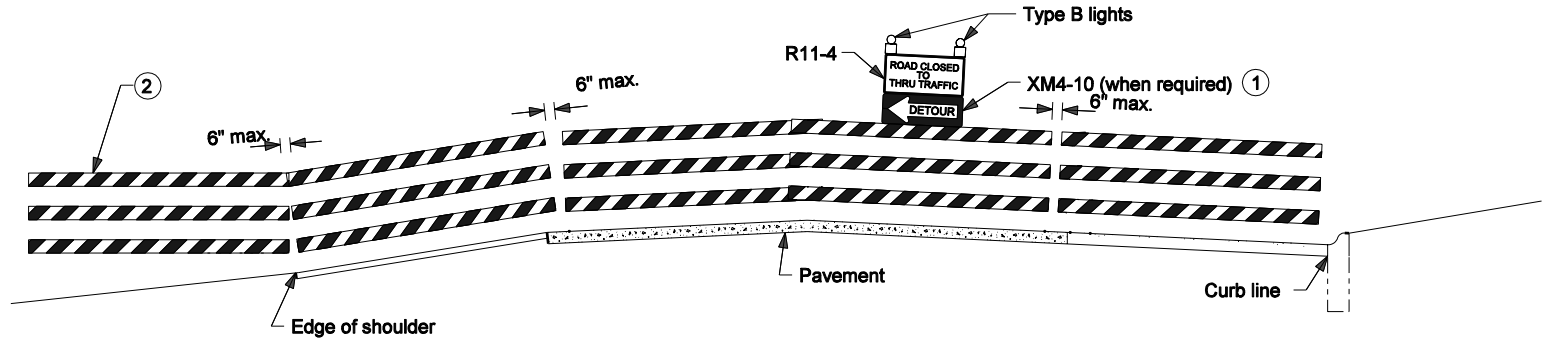

(HALF ELEVATION WITH SHOULDER SECTION)

ELEVATION

(HALF ELEVATION WITH CURB SECTION)

**TYPICAL APPLICATIONS OF TYPE III BARRICADES  
ROAD CLOSED TO THRU TRAFFIC**

INDIANA DEPARTMENT OF TRANSPORTATION

**TYPE III BARRICADE  
TYPICAL APPLICATION**

MARCH 2005

STANDARD DRAWING NO. E 801-TCDV-06

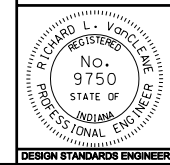

/s/ Richard L. VanCleave 3-01-05  
DESIGN STANDARDS ENGINEER DATE

/s/ Richard K. Smutzer 3-01-05  
CHIEF HIGHWAY ENGINEER DATE

DESIGN STANDARDS ENGINEER

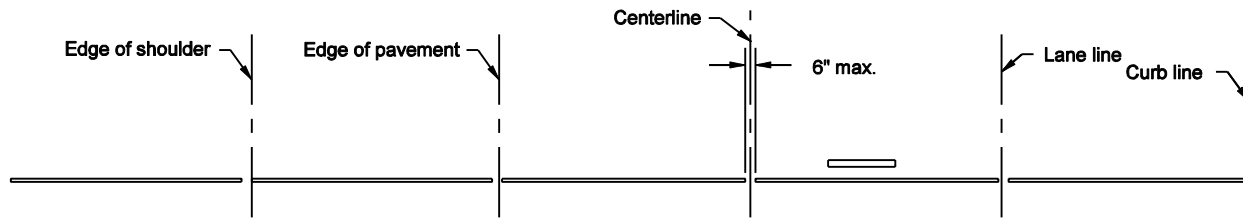

(HALF PLAN WITH SHOULDER SECTION)

(HALF PLAN WITH CURB SECTION)

**PLAN VIEW**

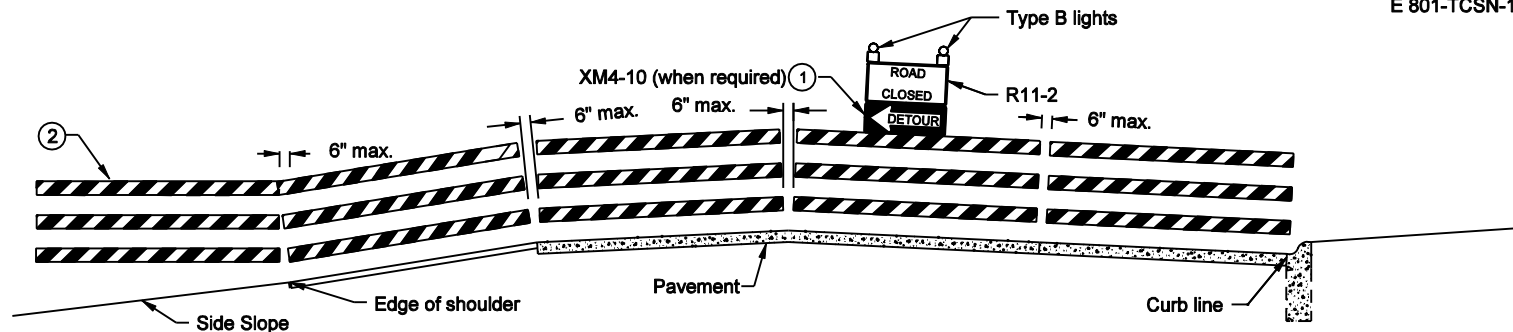

(HALF ELEVATION WITH SHOULDER SECTION)

(HALF ELEVATION WITH CURB SECTION)

**ELEVATION**

**TYPICAL APPLICATIONS OF TYPE III BARRICADES  
ROAD CLOSED TO ALL TRAFFIC**

**GENERAL NOTES**

- ① The Detour Arrow sign shall be used only when a detour route has been signed.
- ② Barricades shall be supported on driven posts in areas outside of the pavement or sidewalk, where side slopes are 3 to 1 or flatter.
3. See standard drawing E 801-TCDV-04 for sign use and mounting information.
4. Barricades and supports shall meet NCHRP 350 crash evaluation criteria.
4. See Note 5 on Standard Drawing E 801-TCSN-11 for post depth.

INDIANA DEPARTMENT OF TRANSPORTATION

**TYPE III BARRICADE  
TYPICAL APPLICATIONS**

SEPTEMBER 2002

STANDARD DRAWING NO. E 801-TCDV-07

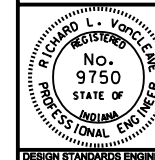

*/s/ Richard L. VanCleave* 9-03-02  
DESIGN STANDARDS ENGINEER DATE

*/s/ Richard K. Smutzer* 9-03-02  
CHIEF HIGHWAY ENGINEER DATE

DESIGN STANDARDS ENGINEER

**GENERAL NOTES**

- ① The spacer thickness shall be  $\frac{1}{8}$  in. less than the gap between the posts when positioned in the unbolted configuration.
- ② The exterior bolt, spacer, washer, and nut shall be installed in a prepunched hole within the first 2 in. of the end of the lapped post section.
- ③ The interior bolt, spacer, washer, and nut shall be installed in a prepunched hole within the first 2 in. of the exterior bolts. The maximum spacing between the interior bolts shall be 1'-6". If the length of the post lap is increased such that this 1'-6" maximum is exceeded, then additional interior bolts shall be installed such that the maximum space between adjacent interior bolts does not exceed the 1'-6" limit.
- ④ The driven post shall always be mounted in front of the upper post with respect to adjacent oncoming traffic, regardless of the direction the sign is facing.
5. The bolts shown shall be  $\frac{5}{8}$ " x 2".

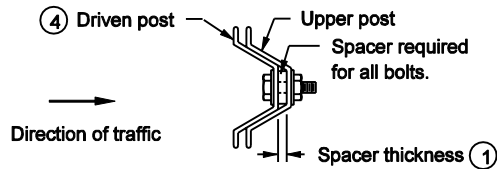

**SECTION "A-A"**

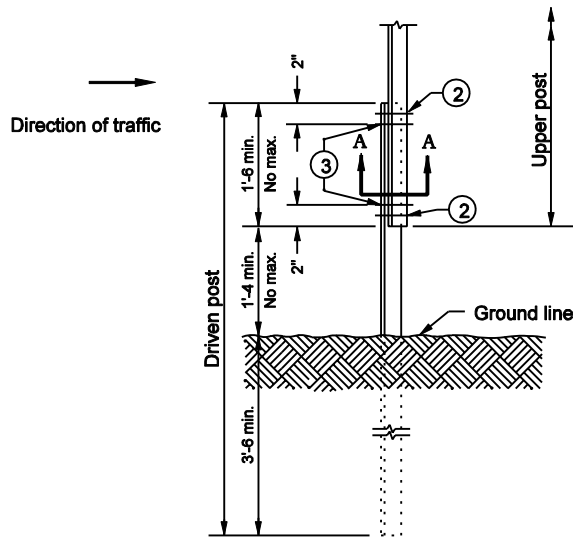

**ELEVATION**

**U CHANNEL STEEL POST SPLICE**

INDIANA DEPARTMENT OF TRANSPORTATION	
<b>U CHANNEL STEEL POST SPLICE DETAIL</b>	
SEPTEMBER 2002	
STANDARD DRAWING NO. E 801-TCDV-08	
	<i>/s/ Richard L. VanCleave</i> 9-03-02 DESIGN STANDARDS ENGINEER      DATE
	<i>/s/ Richard K. Smutzer</i> 9-03-02 CHIEF HIGHWAY ENGINEER      DATE
DESIGN STANDARDS ENGINEER	



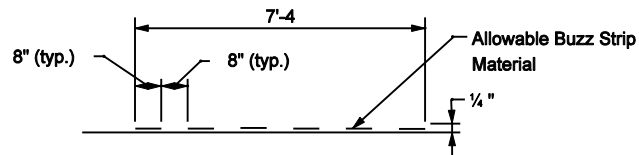
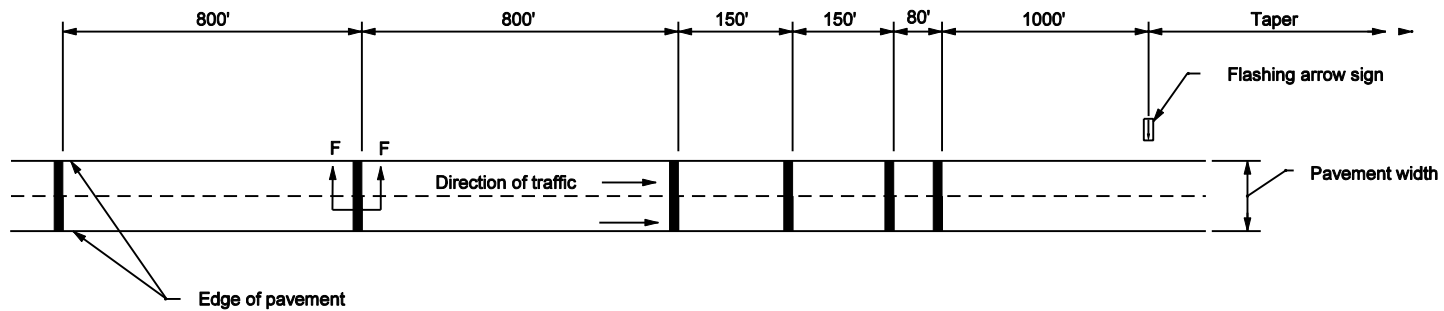

**SECTION F-F**  
(Typ.)

INDIANA DEPARTMENT OF TRANSPORTATION	
<b>BUZZ STRIP INSTALLATION</b>	
MARCH 2003	
STANDARD DRAWING NO. E 801-TCDV-09	
	/s/ Richard L. VanCleave 3-03-03 DESIGN STANDARDS ENGINEER DATE
	/s/ Richard K. Smutzer 3-03-03 CHIEF HIGHWAY ENGINEER DATE
DESIGN STANDARDS ENGINEER	

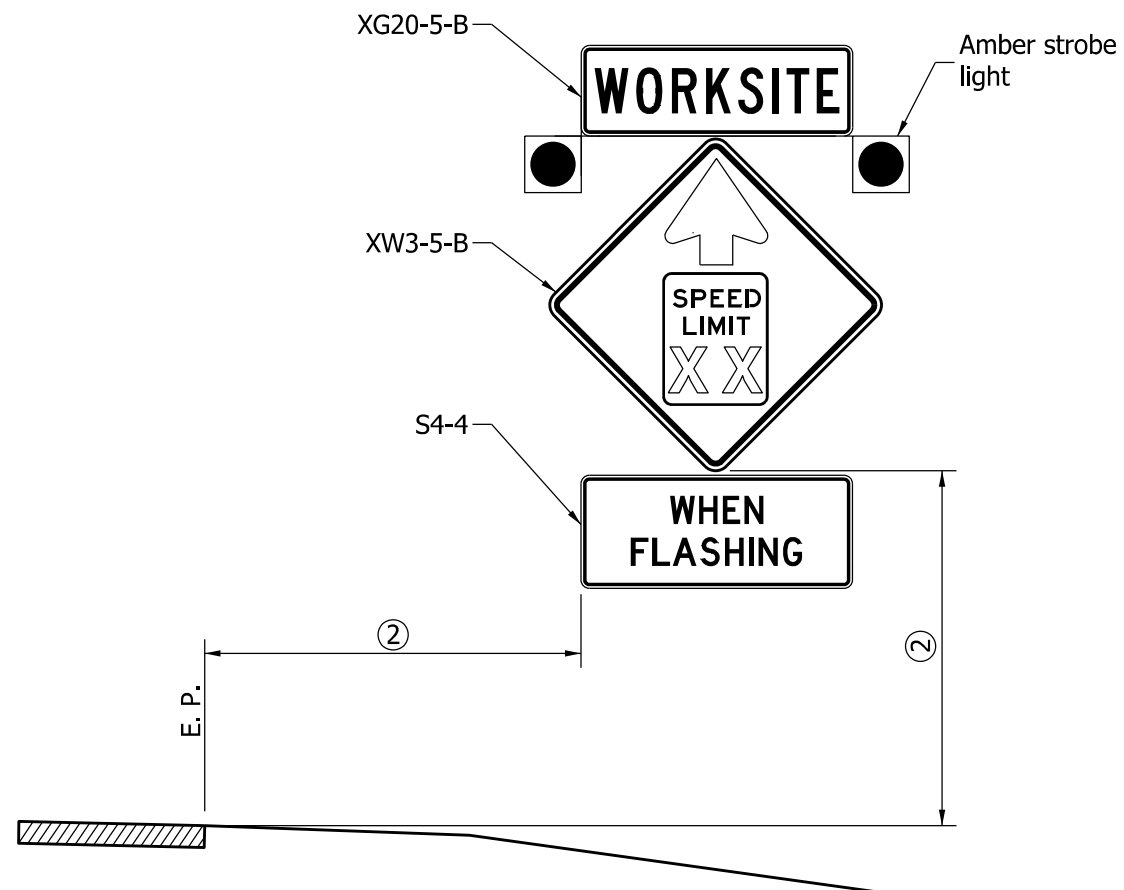

REDUCED SPEED ADVANCE  
WARNING SIGN ASSEMBLY

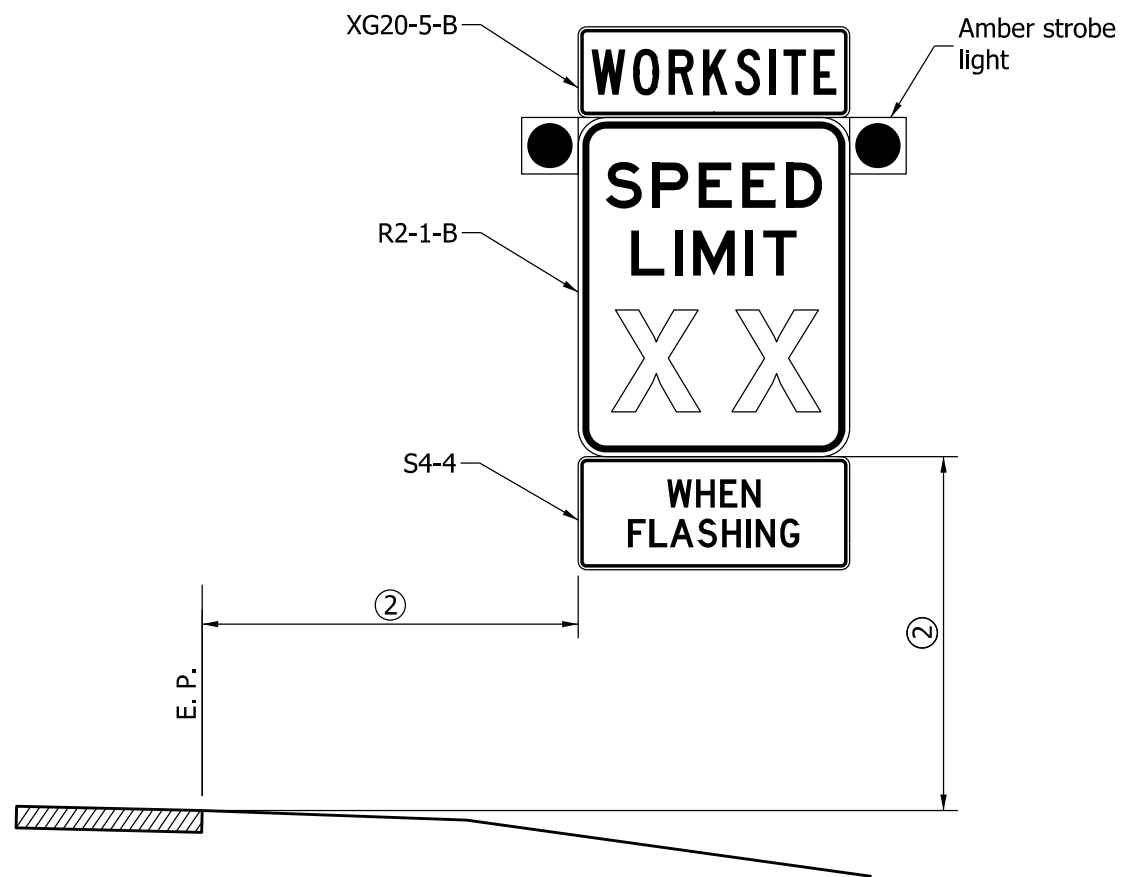

WORKSITE SPEED LIMIT  
SIGN ASSEMBLY

**NOTES:**

1. If not trailer mounted, signs and supports shall satisfy NCHRP 350 crash evaluation criteria.
- ② See Standard Drawing 801-TCDV-05 for lateral and vertical placement.
3. Advance warning sign speed limit shall match that on worksite speed limit sign.
4. The worksite speed limit shall be at least 10 mph below the posted speed limit for the roadway under construction.
5. Sign series shown is for freeway or expressway application.

INDIANA DEPARTMENT OF TRANSPORTATION									
WORKSITE SPEED LIMIT SIGN ASSEMBLY FOR INTERMITTENT USE (When Workers Present) SEPTEMBER 2012									
STANDARD DRAWING NO. E 801-TCDV-10									
	<table style="width: 100%; border-collapse: collapse;"> <tr> <td style="width: 70%; border-bottom: 1px solid black;">/s/ <i>Richard L. VanCleave</i></td> <td style="width: 30%; border-bottom: 1px solid black;">09/04/12</td> </tr> <tr> <td style="font-size: small;">SUPERVISOR, ROADWAY STANDARDS</td> <td style="font-size: small;">DATE</td> </tr> <tr> <td style="border-bottom: 1px solid black;">/s/ <i>Mark A. Miller</i></td> <td style="border-bottom: 1px solid black;">09/04/12</td> </tr> <tr> <td style="font-size: small;">CHIEF ENGINEER</td> <td style="font-size: small;">DATE</td> </tr> </table>	/s/ <i>Richard L. VanCleave</i>	09/04/12	SUPERVISOR, ROADWAY STANDARDS	DATE	/s/ <i>Mark A. Miller</i>	09/04/12	CHIEF ENGINEER	DATE
/s/ <i>Richard L. VanCleave</i>	09/04/12								
SUPERVISOR, ROADWAY STANDARDS	DATE								
/s/ <i>Mark A. Miller</i>	09/04/12								
CHIEF ENGINEER	DATE								

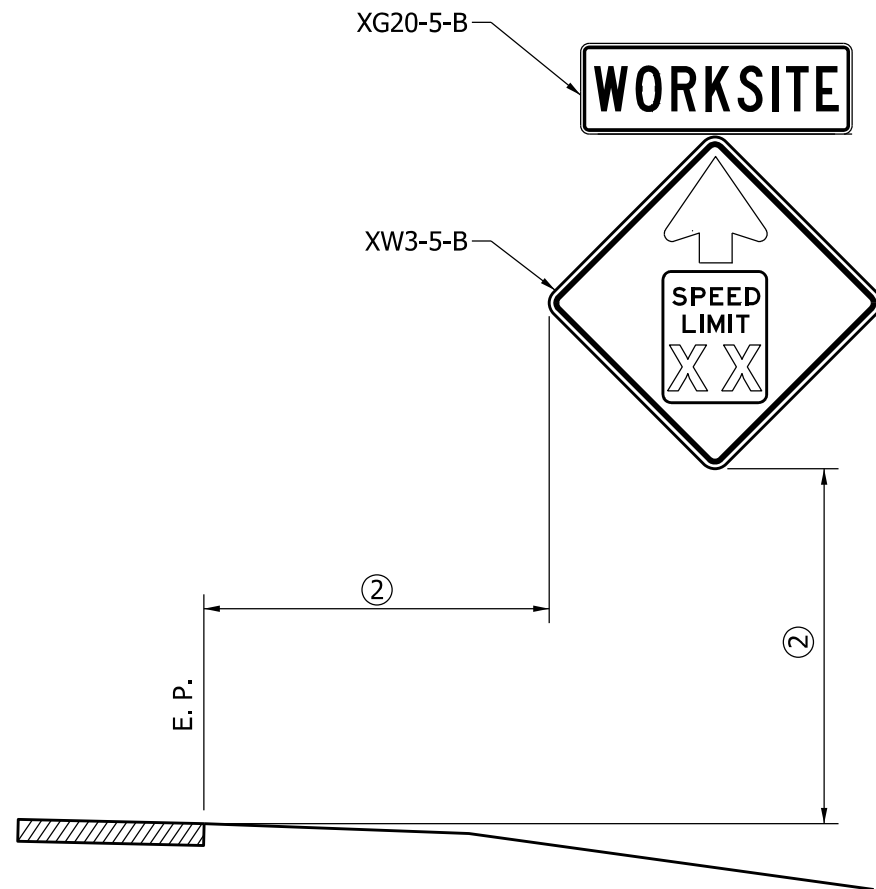

REDUCED SPEED ADVANCE  
WARNING SIGN ASSEMBLY

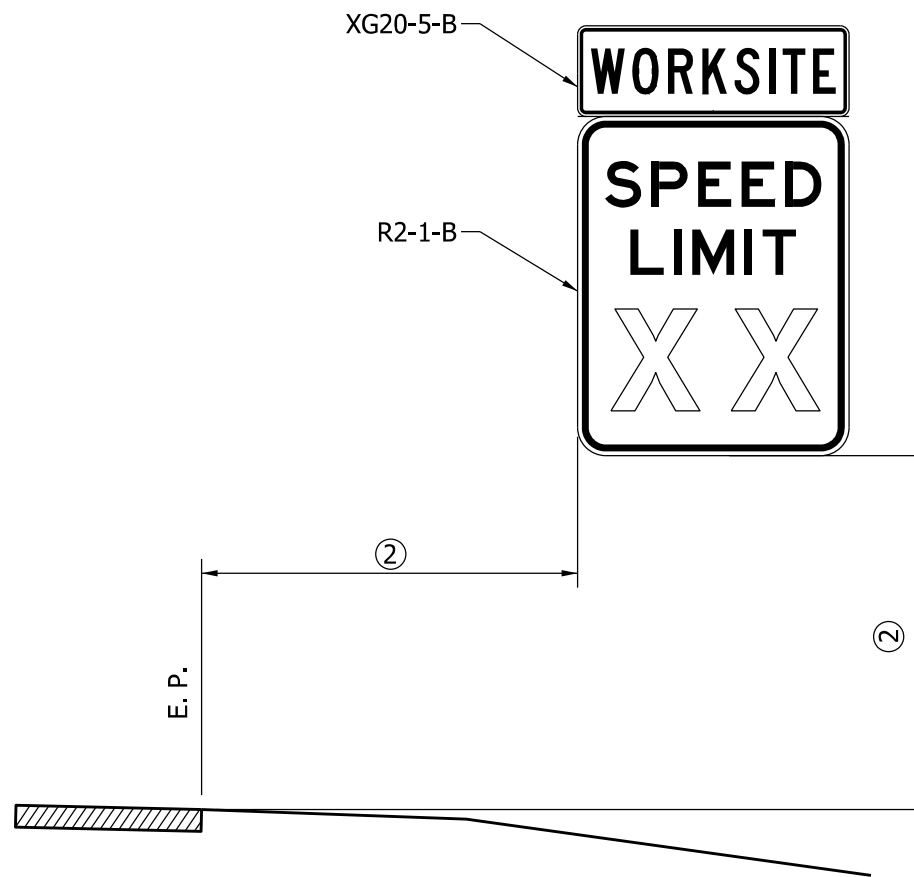

WORKSITE SPEED LIMIT  
SIGN ASSEMBLY

**NOTES:**

1. If not trailer mounted, signs and supports shall satisfy NCHRP 350 crash evaluation criteria.
- ② See Standard Drawing 801-TCDV-05 for lateral and vertical placement.
3. Advance warning sign speed limit shall match that on worksite speed limit sign.
4. The worksite speed limit shall be at least 10 mph below the posted speed limit for the roadway under construction.
5. Sign series shown is for freeway or expressway application.

INDIANA DEPARTMENT OF TRANSPORTATION									
WORKSITE SPEED LIMIT SIGN ASSEMBLY (For Continuous Use) SEPTEMBER 2012									
STANDARD DRAWING NO. E 801-TCDV-11									
	<table style="width: 100%; border-collapse: collapse;"> <tr> <td style="width: 70%; border-bottom: 1px solid black;">/s/ <i>Richard L. VanCleave</i></td> <td style="width: 30%; border-bottom: 1px solid black;">09/04/12</td> </tr> <tr> <td style="font-size: small;">SUPERVISOR, ROADWAY STANDARDS</td> <td style="font-size: small;">DATE</td> </tr> <tr> <td style="border-bottom: 1px solid black;">/s/ <i>Mark A. Miller</i></td> <td style="border-bottom: 1px solid black;">09/04/12</td> </tr> <tr> <td style="font-size: small;">CHIEF ENGINEER</td> <td style="font-size: small;">DATE</td> </tr> </table>	/s/ <i>Richard L. VanCleave</i>	09/04/12	SUPERVISOR, ROADWAY STANDARDS	DATE	/s/ <i>Mark A. Miller</i>	09/04/12	CHIEF ENGINEER	DATE
/s/ <i>Richard L. VanCleave</i>	09/04/12								
SUPERVISOR, ROADWAY STANDARDS	DATE								
/s/ <i>Mark A. Miller</i>	09/04/12								
CHIEF ENGINEER	DATE								

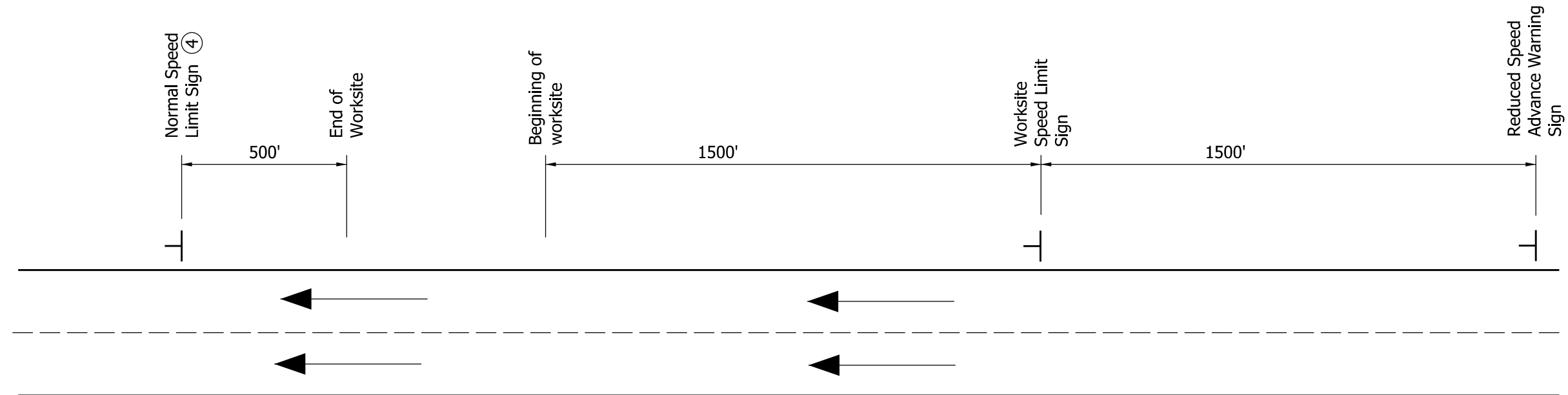

**NOTES:**

1. Worksite speed limit sign assemblies shall be placed on both sides of the roadway only where all travel lanes approaching the construction site are open to traffic traveling in the same direction.
2. Worksite speed limit sign assemblies shall be placed 500 ft beyond each crossroad or the last entrance ramp for each interchange, at 2-mile intervals throughout the worksite, or adjacent to the existing normal speed limit signs.
3. See Standard Drawings E 801-TCDV-10 and -11 for additional notes on assembly requirements.
- ④ For a rural Interstate route application, a truck speed limit sign shall be used and placed immediately to the right of the normal speed limit sign.

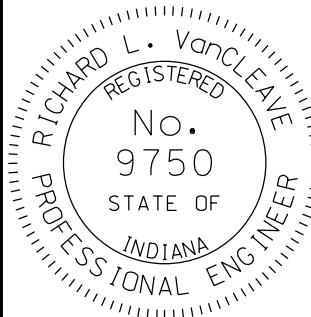
INDIANA DEPARTMENT OF TRANSPORTATION									
<b>WORKSITE SPEED LIMIT SIGN ASSEMBLY LONGITUDINAL PLACEMENT SEPTEMBER 2012</b>									
STANDARD DRAWING NO. E 801-TCDV-12									
	<table style="width: 100%; border-collapse: collapse;"> <tr> <td style="width: 70%; border-bottom: 1px solid black;"><i>/s/ Richard L. VanCleave</i></td> <td style="width: 30%; border-bottom: 1px solid black; text-align: right;">09/04/12</td> </tr> <tr> <td style="font-size: small;">SUPERVISOR, ROADWAY STANDARDS</td> <td style="font-size: small; text-align: right;">DATE</td> </tr> <tr> <td style="border-bottom: 1px solid black;"><i>/s/ Mark A. Miller</i></td> <td style="border-bottom: 1px solid black; text-align: right;">09/04/12</td> </tr> <tr> <td style="font-size: small;">CHIEF ENGINEER</td> <td style="font-size: small; text-align: right;">DATE</td> </tr> </table>	<i>/s/ Richard L. VanCleave</i>	09/04/12	SUPERVISOR, ROADWAY STANDARDS	DATE	<i>/s/ Mark A. Miller</i>	09/04/12	CHIEF ENGINEER	DATE
<i>/s/ Richard L. VanCleave</i>	09/04/12								
SUPERVISOR, ROADWAY STANDARDS	DATE								
<i>/s/ Mark A. Miller</i>	09/04/12								
CHIEF ENGINEER	DATE								